

---

**Note:** The Bioer Co. reserves the right to modify this manual at any time without notice.

---

Patent materials are included in this manual. All rights reserved. No part of this manual shall be photocopied, reproduced, or translated into other languages, without written permission from the Bioer Co.

Please read this manual carefully before the Thermal Cycler is first

**Patent No.:** ZL 98 2 44367.6  
**Standard No.:** YZB/ 0189 - 2008

**Document Number:** BYQ60410000000ESM  
**Document Version:** Jan, 2011    **Version 1.8**

## Important Note

### 1 CONVENTIONS

---

<b>Note:</b>	Because of the important information in this column, please read it carefully. Failure to follow the advice in this column will possibly result in damage or malfunctioning of the Thermal Cycler.
--------------	--

---

---

<b>Warning!</b>	This symbol means that you should be cautious to take an operation/procedure. Failure to follow the requirements in this column will possibly result in personal injury.
-----------------	--

---

### 2 SAFETY

During the operation, maintenance, or repair of the Thermal Cycler, the following safety measures should be taken. Otherwise, the guard provided by the Thermal Cycler is likely to be damaged, the rated safety level to be reduced, and the rated operation conditions to be affected.

*The Bioer Co. shall not be in any way responsible for the consequences resulted from buyer's not observing the following requirements.*

---

<b>Note:</b>	The Thermal Cycler, complying with the National Standard EN61010-2-010 : 2003 & EN61326-1 : 2006, is a general instrument of class I , the protection degree is IP20. It is intended for indoor use.
--------------	--

---

#### a) Grounding Considerations

A.C. power's grounding should be reliable for fear of an electric shock. The 3-pin plug with the Thermal Cycler's power line is a safety device that should be matched with a grounded socket. Never let the third ground pin floating. If the 3-pin plug cannot be inserted, it is recommended to ask an electrician to install an appropriate power socket.

#### b) Keep Away from Electric Circuits

The operator is not allowed to open the Thermal Cycler. Changing components or adjusting certain parameters inside the device must only be accomplished by the certificated professional maintenance personnel. Do not change elements while the power is still on.

#### c) A.C. Power Considerations

Before turn on the power, always check if the mains voltage is within the required ~220-240V(or ~100-120V) and if the current rating of the power socket meet the required specification, i.e. 200W.

#### d) A.C. Power Line Considerations

As an accessory of the Thermal Cycler, the A.C. power line should be a default one. If it is damaged, the A.C. power line may not be repaired, but it must be replaced with a new one. The power line should be free of heavy objects during the Thermal Cycler's operation. Keep the power line away from the place where people gather regularly.

#### e) Connect the A.C. Power Line

While connect or disconnect the power line, you should hold the 3-pin plug with your hand. Insert the plug thoroughly to ensure good contact between the plug and socket. Pull the plug, not the line, when you need to disconnect to the mains.

## f) Design Environments

The Thermal Cycler should be placed in a low-humidity, dust-free, and good-ventilation room without caustic gas or powerful magnetic interference. In addition, water sources, such as pools and water pipes, should be separated a distance from the Thermal Cycler.

Never cover or obstruct the openings of the Thermal Cycler, which are designed for ventilation and to prevent the device's interior from being too hot. When a single device is running, the shortest distance between its openings and the nearest object is 50cm; otherwise, when two devices or above are running at the same time, the shortest distance is 100 cm. Do not place the device on a soft surface, because that will result in adverse ventilation near the device's bottom openings.

Too high temperature will lead to degraded performance or failure of the Thermal Cycler. Therefore, the device should be protected against any kind of heat sources like sunlight, ovens, or central heating equipment.

If the Thermal Cycler is set aside for a long time, it is recommended to disconnect the power line to mains and cover the device with a piece of soft cloth or plastic to prevent dust from entering.

---

<b>Note:</b>	Once one of the following events occurs, you are suggested to disconnect the power line with mains, and contact the distributor or ask a certificated maintenance worker for help. <ul style="list-style-type: none"> <li>● Liquid into the device;</li> <li>● The device sprinkled or drenched;</li> <li>● The device malfunctioning, giving off abnormal sound or odor;</li> <li>● The device falling onto the floor or its shell damaged;</li> <li>● Significant changes in the device's performance.</li> </ul>
--------------	---

---

## 3 EMC Consideration

---

<b>Note:</b>	This is a class A equipment, only suitable for use in establishments other than domestic, and those directly connected to a low voltage power supply network which supplies buildings used for domestic purpose.
--------------	--

---

## 4 Protection Degree: IP 20

## 5 LABELS

## a) Tablet

	<b>BIOER TECHNOLOGY CO., LTD.</b>
Name: Thermal Cycler      Model: TC-*/H(b)	
Power: ~220-240V    200W    50/60Hz	
Fuse: 250V 2.5A(Φ5×20)    Sort: class I    IP20	
SN: BYQ*****_***	Date: ****. **

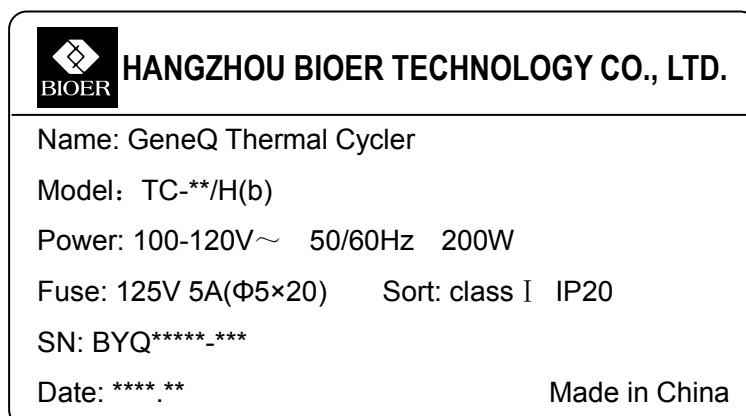

## b) Warning Sign



---

**Warning!** There are two warning signs read 'HOT SURFACE !'. The metal part near those signs (on the block and hotlid) is not allowed to be touched by any part of the body for fear of the body burn, during the program execution and in the short period after the program execution!

---

## 6 MAINTENANCE

The conical holes over the block should be cleaned regularly with soaked cotton swab. That ensures sufficient contact and thus good heat conduction between each conical hole and the tube inside it.

In case it is smeared, the surface of the Thermal Cycler may be scrubbed with a piece of dehydrated soft wet cloth.

---

**Warning!** During surface cleaning, the power must be off.  
Corrosive scour is not allowed to clean the surface.

---

## 7 WARRANTY AND SERVICE INFORMATION

## a) Warranty

The Thermal Cycler is warranted for a period of one month, from date of shipment from the company, to be free from defects in material and workmanship. The Bioer Co. shall be obligated, under this warranty, to exchange the Thermal Cycler which proves to be defective as described herein.

The Thermal Cycler is also warranted for a period of eighteen months, from date of shipment from the company, to be free from defects in material and workmanship. The Bioer Co.'s obligation under this warranty shall be limited to repair or exchange (at the Bioer Co.'s option) of the Thermal

Cycler which proves to be defective as described herein.

The buyer is responsible for freight to the maintenance shop designated by the Bioer Co. on all warranty claims. The buyer is also responsible for the transportation expenses of the freight to the maintenance shop. The Bioer Co. shall be responsible for the transportation expenses of the freight to the buyer (which is only applicable to domestic buyers).

After the warranty comes due, the Bioer Co. reserves the right to charge cost price for maintenance of a defective device.

b) Warranty Terms

The above warranty is not applicable to defective devices with incorrect use, abnormal operating conditions, improper application, and unauthorized maintenance or alteration.

*The Bioer Co. makes no express warranties other than those which are described herein. Any descriptions in sales promotion under specific conditions shall not create an express warranty that the goods shall conform to such description.*

c) After-sell services hotline:0086-571-87774558

---

**Note:**

Once it is opened, the package should check according to the checklist. If the buyer finds any items to be missing or damaged, do not hesitate to contact the distributor.

After the acceptance check is passed, the buyer should fill out the check form and send its photocopy (or fax it) to the distributor. The Bioer Co. establishes the archives and maintenance record with the returned form.

Please store the package and packing materials in a safe place in case of future device maintenance. The above warranty does not extend to goods damaged as result of cheesy package.

---

## CONTENTS

CHAPTER 1 INTRODUCTION .....	1
1 PCR Technique .....	1
2 PCR Applications .....	1
3 PCR Thermal Cyclers .....	2
4 Common PCR Thermal Cyclers .....	2
5 Features of the Gene Q Thermal Cycler .....	3
CHAPTER 2 SPECIFICATIONS .....	4
1 Normal Operating Conditions .....	4
2 Transportation and Storage Conditions .....	4
3 Basic Parameters .....	4
4 Performance .....	5
5 Software Functions .....	5
CHAPTER 3 PREPARATIONS .....	6
1 Instructure Description .....	6
2 Keyboard Diagram .....	7
3 Key Functions .....	7
4 Inspection before Power-on .....	8
5 Power-on Procedures .....	8
CHAPTER 4 OPERATION GUIDE .....	9
1 How to Run a PCR Program .....	9
2 How to edit a PCR program .....	10
3 How to Set System Parameters .....	14
CHAPTER 5 UPGRADE OF SOFTWARE .....	16
1 To Install Upgrading Software .....	16
2 To Modify, Repair or Remove the Upgraded Software .....	18
3 Preparation before Upgrading .....	19
4 How to Upgrade the Software .....	19
CHAPTER 6 FAILURE ANALYSIS AND PROCESSING .....	21
1 Failure Analysis and Processing Procedures .....	21
2 Blocks Error Message .....	22
APPENDIX 1 Connection Diagram (1/2) .....	23
APPENDIX 2 Parameter Value & Meaning .....	25

## CHAPTER 1 INTRODUCTION

This chapter briefly introduces PCR technique and its applications, PCR thermal cyclers, and the characteristics of our Gene Q Thermal Cycler.

### 1 PCR Technique

PCR (Polymerase Chain Reaction), or cell-free molecule cloning, is a technique for amplifying nucleic acids in vitro, emulating natural DNA replication process. The PCR technique, using two DNA strands to be amplified as template, and a pair of synthetic oligonucleotides as primers, rapidly reproduces the specific DNA pieces under the catalysis of a thermostable DNA polymerase. Because of its simplicity, rapidity, specificity, and sensitivity, PCR has been widely applied to all fields of life sciences since its invention by Mullis in 1983 and the discovery of the thermostable DNA polymerase by Erlich in 1989. Great achievements have been obtained in PCR's applications in such areas as cytology, virology, oncology, genetics, forensics, and immunology. PCR technology is a milestone in the history of modern molecular biology.

### 2 PCR Applications

Research Areas	Gene cloning, DNA sequencing, mutation analysis, gene recombination and mutagenesis, identification and adjustment of DNA sequence of protein structure, detection of gene extension, construction of synthetic genes, construction of cloning and expression carrier, detection of polymorphism of a gene's inscribed enzyme;
Clinical Diagnoses	Bacteria(spirochaeta, rickettsia, diphtheria bacillus, colon bacillus, dysentery bacillus, and clostridium); Virus(HTLV, HIV, HBV, HCV, HPVS, EV, CMV, EBV, HSV, measles virus, rotiform virus, B19 virus, and Lhasa virus); Parasite(malaria); Human hereditary diseases(Lesh-Nyhan syndrome, hemophilia,BMD, and DMD);
Immunology	HLA locus typing, qualitative analysis of T-cell receptor or antibody diversification, immune body gene mapping, quantitative analysis of lymph genes;
Human Genome Project	Identification of DNA markers using discrete repetitive ; Sequence, construction of a genetic linkage map(detection of DNA, polymorphism, or semen mapping ); Construction of a physical map, sequencing, and map expression;
Forensics	Specimen analysis in the venue, and HLA-Dq locus typing;
Oncology	Pancreas cancer, rectum cancer, lung cancer, thyroid gland cancer, melanin cancer, and leukemia;
Social and Colony Biology	Genetic species research, evolution research, animal protection research, ecology, environmental sciences, and experimental genetics;
Paleontology	Specimen analysis in archeology and museum;
Biology	Diagnosis of animal hereditary diseases and detection of plant pathogeny.

### 3 PCR Thermal Cyclers

A PCR thermal cycler is a key device throughout the PCR experiment. Its performance determines the accuracy of the experimental results. Its parameters, such as temperature keeping and temperature ramp rate, play an extremely important role in DNA denaturation, annealing and extension.

#### Chief Specifications of a PCR Thermal Cycler:

Temperature display accuracy	The bias between display temperature and practical temperature, directly affects the quality of DNA annealing, elongation, and denaturation, and should be reduced to an accepted level;
Heating/Cooling Rate	Higher cooling/heating rate can greatly decrease the experimental time and maintain the enzyme's activity;
Temperature Uniformity	Excellent temperature uniformity guarantees consistent amplification conditions for the same batch of reaction samples and then avoids false positive or negative of the results caused by mismatched operating conditions;
Temperature Control Accuracy	Higher temperature control accuracy ensures temperature stability during the PCR amplification reaction, and therefore increase the reliability of the experimental results;
Intelligent Degree	More intelligent thermal cycler means less labor intensity for test personnel and ensures the whole PCR reaction to be accomplished successfully.

### 4 Common PCR Thermal Cyclers

#### a) Gradient Water Bath Thermal Cyclers

A gradient water bath thermal cycler consists of three water baths operating at different temperatures. An automatic mechanical manipulator soaks the sample tube containing reactants in the three water baths cyclically, and thus finishes the three processes of denaturation, annealing and extension.

This device has high temperature control accuracy, high heating/cooling rate, and excellent temperature uniformity. However, its intelligent level is very low, and it cannot accomplish some relatively complex PCR processes. There are other disadvantages associated with this type of thermal cycler, such as liquid evaporation in the bath, lack of the soak mode, inability of long-term operation without human interference, temperature fluctuation caused when the sample tube is put into the bath during heating/cooling process, and last but not least, the pollution issue. As a result, this kind of thermal cycler has gradually been abandoned in the market.

#### b) Compressor Cooling Thermal Cyclers

At the center of a compressor cooling thermal cycler is located a block made of good conduction material (aluminum or silver), over which several conical holes are distributed. Each of the conical holes has the same shape as a standard microcentrifugal tube to ensure good contact between the two. The resistance heater on the block's outside bottom is responsible for block heating, whereas the compressor takes charge of block cooling. Controlling the heater and compressor with a microcomputer completes the required heating, cooling, and temperature keeping processes.

This device has much higher intelligent level and smaller size compared to a gradient water bath thermal cycler. Nevertheless, the compressor's inertia not only limits the cooling rate (to about 1°C/sec), but also increases the temperature undershoot. Moreover, there exists temperature gradient over the block near the inlet and outlet of the compressor's evaporation pipe (lower temperature near the inlet area and higher temperature near the outlet area).



### c) Thermoelectric Cooling Thermal Cyclers

These are the most advanced thermal cyclers by far. A thermoelectric cooling thermal cycler also has a metal block at its center (like a compressor cooling thermal cycler). A thermoelectric module closely attached to the block's outside bottom accomplishes Block heating and cooling. Not only does this device inherit such features as high intelligent level and small size from a compressor cooling thermal cycler, but it also has higher temperature control accuracy and heating/cooling rate, thanks to the module's excellent temperature response characteristics. And the temperature uniformity across the block is much better compared to a compressor cooling thermal cycler because the modules are distributed over the block's outside bottom.

During its early development, a thermoelectric module was not able to withstand rapid and frequent heating or cooling for long. With improved workmanship, this difficulty has been overcome. Current long service-life thermoelectric modules have the capability of enduring such harsh conditions in a thermal cycler. As result, thermoelectric cooling thermal cyclers have gradually dominated the market.

## 5 Features of the Gene Q Thermal Cycler

The Gene Q Thermal Cycler is a thermoelectric cooling thermal cycler. It features:

- a) Reliable and stable operation, because the thermoelectric module is manufactured via the U.S. ITI's thermoelectric cooling technique and the Japanese quality management model;
- b) High heating/cooling (heating rate  $\geq 5.0^{\circ}\text{C}/\text{sec.}$ , and cooling rate  $\geq 4.0^{\circ}\text{C}/\text{sec.}$ ), which greatly reduces experimental time;
- c) Automatic temperature ramp control, which allows different heating/cooling ramp settings so that the device can emulate other thermal cycler's temperature control process;
- d) Automatic temperature and time increments/decrements during cycling program execution,
- e) optimizing the PCR amplification conditions;
- f) Automatic link among files, allowing a complex PCR amplification program to be executed;
- g) The soak mode at a temperature up to  $4^{\circ}\text{C}$  without human interference, after normal cycling program execution;
- h) Instant inspection of total execution time and remaining execution time;
- i) Optional heated lid, preventing the sample in a centrifugal tube from evaporation, which makes paraffin oil unnecessary and operation more convenient, and reduces the sample processing time;
- j) Auto-restart in case of power failure, restoring the data before interrupting and continuing to perform the previously interrupted program.

## CHAPTER 2 SPECIFICATIONS

This chapter describes the Thermal Cycler's operation, transportation and storage conditions, basic parameters, performance and functions.

### 1 Normal Operating Conditions

Ambient temperature: 10°C~30°C  
 Relative humidity: ≤70%  
 Power supply: ~220-240V, 50/60Hz, 200W  
 100-120V~, 50/60Hz, 200W

---

**Note:** Before power-on, please check if the above operating conditions are satisfied. Pay special attention to the power line's reliable grounding.

---

### 2 Transportation and Storage Conditions

Ambient temperature: -20°C~+55°C  
 Relative humidity: ≤80%

### 3 Basic Parameters

Model Parameters	TC-18/H(b)	TC-24/H(b)
Sample Number	18	24
Tube Volume (ml)	0.5	0.2
Size (mm)	297×212×200 (L×W×H)	
Display Screen	320×240 LCD	
Weight (kg)	3.2	
Fuse	250V 2.5A (Φ5×20mm)	
	125V 5A (Φ5×20mm)	
Computer Interface	RS232	

## 4 Performance

Temperature range:	4°C~99°C
Heating rate:	≥5.0°C/sec(max)
Cooling rate:	≥4.0°C/sec(max)
Temperature control accuracy:	≤±0.3°C
Temperature uncertainty:	≤±0.2°C
Temperature display accuracy:	≤±0.5°C
Block temperature uniformity:	≤±0.5°C
Hotlid work temperature range:	105°C±5°C

**Note:** ① *Testing conditions for performance above:*

*Ambient temperature:23±5 °C, humidity≤70%*

② *Testing temperature for temperature control accuracy and block temperature uniformity:55 °C, 72 °C, 95 °C*

Max. number of cycles:	99
Max. procedures within a cycle:	9
Max. temperature keeping time:	99 min. 59 sec.
Max. incubation and in situ time:	99 hour 59 min.
Programs storage:	100

## 5 Software Functions

File editing and saving  
 File accessing, modifying and deleting  
 Automatic file link  
 Heating/cooling ramp setting  
 Automatic temperature and time increments/decrements during cycling program execution  
 Instantly displaying the data at each phase of program execution  
 Pause of program execution  
 Stop of program execution  
 Auto-restart in case of power failure  
 Sound alarm  
 Estimating total program execution time and remaining program execution time  
 Date and time (year, month, day, hour, minute, second) display and calibration  
 Protecting the device from further damage and alarming in case of failure

---

**Note:** The above software functions are listed just as a reference. The Bioer Co. reserves the right to modify the software functions without notice.

---

## CHAPTER 3 PREPARATIONS

This chapter introduces the Gene Q Thermal Cycler's mechanical structure, the keyboard and each key's functions, and some preparations before power-on.

### 1 Instructure Description

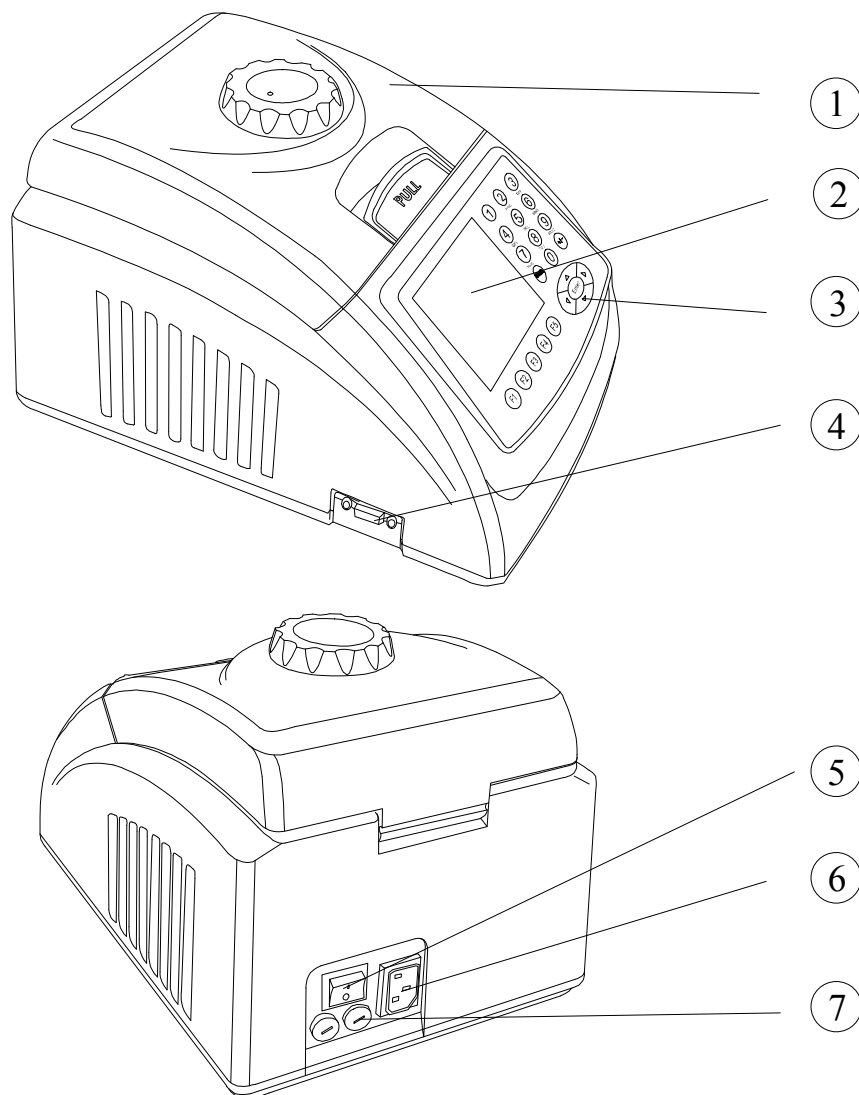

- ① Heated lid & Block    ② Block LCD display    ③ Keyboard    ④ RS232 interface  
 ⑤ Power switch    ⑥ Power connector    ⑦ Fuse Socket

---

**Note:**

- 1 The fuse specifications are as follows: 250V 2.5A(or 125V 5A),  $\phi 5 \times 20$ mm. The fuse should be replaced with one that meets those specifications. If you need certificated fuses, please contact the distributor or manufacturer.
- 2 If you need exchange block, please refer to appendix b Indication to exchange blocks.

---

## 2 Keyboard Diagram

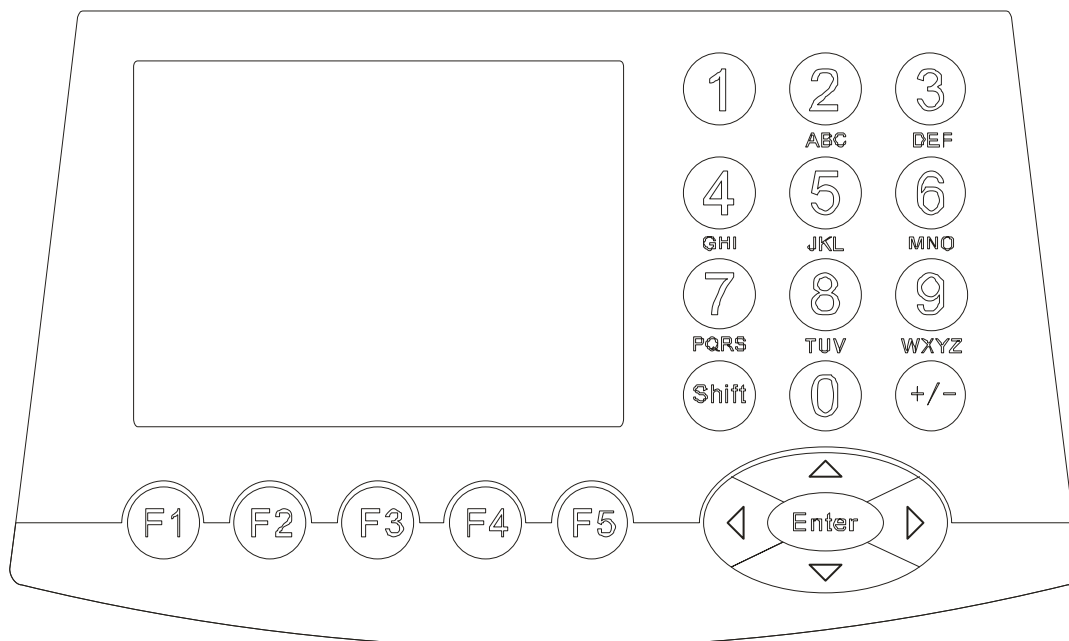

## 3 Key Functions



**“Digit & Letter”**, select the letter by pressing in succession.



**“Function”**, change “+ , -” when editing process temperature and modifying time.

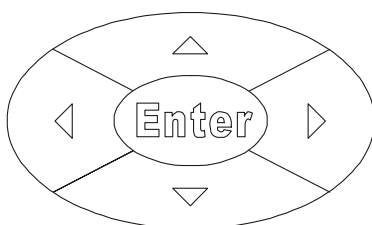

**“Right/Left”**, moving the cursor one position to the left or right when pressing during file parameter setting.

**“Up/Down”**, moving the cursor one position to the up or down when pressing during file parameter setting.

**“Enter”**, press it to accept the present parameters setting displayed on the screen when setting documents.



**“Menu”**, press any button to accept the current items displayed above the button.

## 4 Inspection before Power-on

Before switch the power on, please ensure that:

- 1) Supply voltage falls within the specified limits (refer to Chapter 2);
- 2) The plug has been inserted into the power socket reliably;
- 3) The grounding of the power line is reliable.

## 5 Power-on Procedures

Turn on the power (i.e. turn the power switch to position '1'), the Thermal Cycler will beep twice, and the LCD will display "self test ...". That means the device is under self-testing, which will last for about 1-2 minutes. Please wait patiently. After the self-testing is passed, the main menu is displayed, and the device is ready for operations such as editing, accessing, modifying, or deleting a PCR amplification file.

## CHAPTER 4 OPERATION GUIDE

In this chapter, we will explain in details on operations of every kind of block unit, for example, how to edit, access, modify, delete, or run a PCR amplification file, how to set parameters under different block unit.

---

**Warning!** Please turn off the power immediately and contact the distributor if abnormal sound or display appears after power-on, or if failure alarm and display are found in the process of the device's self-testing.

---

**Note:** If the number of samples is less than the number of conical holes of the block, the sample tubes should be evenly distributed over the block, in order to ensure that the heated lid will stably press on the top of the sample tubes, so that both the block's load and the temperature distribution in each tube are even.

---

**Note:** Before closing the cover, please revolve the knob counter-clockwise according to the knob diagram till there sound "dang, dang....." Please note that the knob can be tightened by revolving clockwise, but can be loosed by revolving counter-clockwise.  
After closing the cover but before power on, please revolve the knob clockwise till it sound "dang,dang....." Revolve the knob one more turn.  
At the beginning of revolving the knob clockwise or counter-clockwise, you can hear "dang,dang...."sound,press the release key by your finger; meanwhile, revolve the knob counter-clockwise for two turns, thus to loose the release key to revolve the knob.

---

### 1 How to Run a PCR Program

Switch the power on, Gene Q Thermal Cycler will beep twice, and it shows the power supply is connected well. The screen will display "**Self testing ●●●●●**", and the instrument will carry on self testing. The self-testing needs about 1~2 minutes and please wait patiently. If the self-testing is successful, the screen will display the main interface.

#### Main interface

On the left top of the main interface it displays the state of Hot lid.

On the central area it displays Bioer Co. information, software version number, block model, default file, default user, control mode and sample volume.

- ✧ Press "**File**" to enter file list interface.
- ✧ Press "**System**" to enter system parameter setting interface.
- ✧ If the default file has no password, press "**Run**" to enter running mode or enter the interface displaying sample volume input window. If the default file has password, press "Run", thus a dialog box will be

Hotlid=off	2008-11-01 10:05:00	
<b>BIOER</b>		
Bioer Technology Co.,Ltd		
Version:	2008-2.0	
Default User:	BIOER	
Default File:	PCR1	
Module Select:	24*0.2	
Control Mode:	Block	
File	System	Run

showed to indicate the user to input the password.

Enter password -
---------------------

Press digital button to enter password directly. Press “Back” to go back the main interface. Press “**Accept**” to confirm the password, thus to enter file running interface or sample volume input window. If the password is wrong, there will be displayed a dialog box as below:

Password error. Try again. -
---------------------------------

Hotlid=off	2008-07-28 10:05:00
<h1>BIOER</h1>	
Bioer Technology Co.,Ltd Version: 2008-2.0 Default User: BIOER Default File: PCR1 Module Select: 24*0.2 Control Mode: Block	
Enter password -	
<input type="button" value="Back"/>	<input type="button" value="Accept"/>

- ✧ If the current Control Mode is Block mode, press “**Accept**” button to enter file running interface. If the current Control Mode is Tube mode, press “**Accept**” button, thus there will be displayed a dialog box to indicate the user to input the sample volume.

Please enter sample volume: 020μl
--------------------------------------

Press **Character button** to input sample volume according to practical condition. Under Tube mode, the overshooting temperature and keeping time will be different in the case of different sample volume.

- ✧ Press “**Back**” to go back the main interface.
- ✧ Press “**Run**” to enter file running interface.

Hotlid=off	2008-07-28 10:05:00
<h1>BIOER</h1>	
Bioer Technology Co.,Ltd Version: 2008-2.0 Default User: BIOER Default File: PCR1 Module Select: 24*0.2 Control Mode: Block	
Please enter sample volume: 020μl	
<input type="button" value="Back"/>	<input type="button" value="Run"/>

## 2 How to Edit a PCR Program

Press “**File**” on the main interface to enter file list interface. There are 3 files listed in the form as showed in the picture. When the flashing bar is flashing in the User Column, select users through pop-up key; at this time, the File Name Column will display the relative files of the selected user dynamically. Shift to the File Name Column, where the flashing bar will flash, then select relative user’s file through pop-up key.



- ✧ Press **“Edit”** to edit the file indicated by the cursor.
- ✧ Press **“New File”** to edit a new file.
- ✧ Press **“Delete”** and the system will alarm **“Do you want to delete the file? Please select ‘F3’ or ‘F4’”**, then according to the alert to select (Delete) or (Back).
- ✧ Press **“Back”** to go back to the main interface.

**File List Interface**

Hotlid=off		2008-07-28 10:05:00	
No.	User	File Name	Save Time
1	BIOER1*	PCR1	2008-07-28
2	BIOER2	PCR2*	2008-07-28
3	BIOER3	PCR3	2008-07-28

- ✧ If the file has no password, press **“Edit”** to enter file editing interface; While if the file has password, press **“Edit”**, thus a dialog will be displayed to indicate the user to enter the password.

Enter password  
 -

Press **Character button** in the main interface to input the password directly. Press **“Back”** to go back file list interface. Press **“Accept”** to confirm the password, and then the system will enter the file editing interface,

- ✧ If the file has no password, press **“Run”** to enter file running interface or sample volume input interface. If the file has password, press **“Run”**, a dialog box will be displayed for inputting the password. Press **“Back”** to go back the file list interface. Press **“Accept”** to confirm the password, and then the system will enter file running interface of sample volume input window.

Hotlid=off		2008-07-28 10:05:00	
No.	User	File Name	Save Time
1	BIOER1*	PCR1	2007-07-28
2	BIOER2	PCR2*	2007-07-28
3	BIOER3	PCR3	2007-07-28

Enter password  
 -

After press **“Run”** in the file list interface, and input the password(If the file has Password.):

- ✧ If the current Control Mode is Block mode, Press **“Accept”** to enter file running interface; while if the current Control Mode is Tube mode, press **“Accept”**, thus a dialog box will be displayed for inputting sample volume.

Please enter sample volume:  
 020µl

Press **Character button** to input sample volume according to practical condition. Press **“Back”** to go back file list interface. Press **“Run”** to enter file running interface.

Hotlid=off		2008-07-28 10:05:00	
No.	User	File Name	Save Time
1	BIOER1*	PCR1	2008-07-28
2	BIOER2	PCR2*	2008-07-28
3	BIOER3	PCR3	2008-07-28

Please enter sample volume:  
 020µl

**Note:** The sign “\*” at the top of User and File indicates the current running file is default one, which can be modified in the parameter setting interface.

**File Edit Interface**

In this interface, you can edit sections and segments of the file. A File is comprised by sections and segments. And the sections contain many segments, which you can set cyclers to be run (refer to the figure). Move cursor by pressing “Up/Down” and “Right/Left”, and the position that the cursor reaches will be displayed in white on a black background. Press “Digit & Letter” to modify parameter settings. Press “+/-” to change +/-.

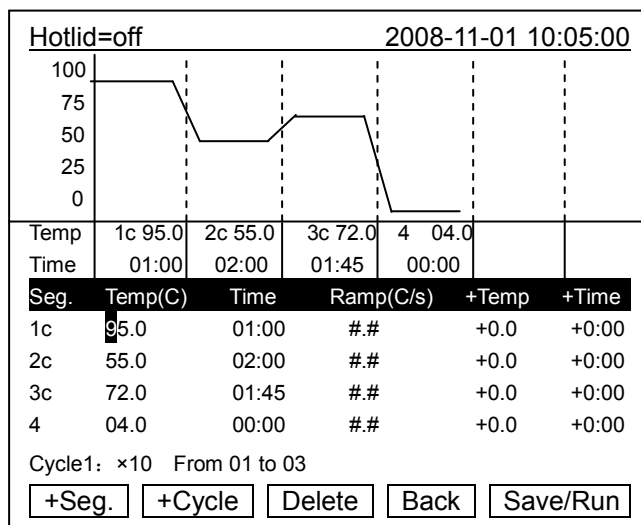

- ✧ Press “+Seg.” to enter segment edit interface. In every segment, you can set setting temperature (Temp), duration (Time), Ramping rate (Ramp), temperature increment of every cycler (+Temp) and time increment of every cycler (+Time). Press “Delete” to delete the present segment.
- ✧ Press “+Cycle” to enter segment edit interface, where you can set cycle numbers and initial cycle segment. The figure shows a cycle from the first segment to the third one, and there are totally 10 times cycles.
- ✧ Press “+Cycle” repeatedly to add sections (max.: 5 sections ). Press “Delete” to delete the present segment. Move cursor by pressing “Up/Down” to enter the former segment or the latter.
- ✧ Press “Save” to enter file save interface.
- ✧ Press “Back” to go back to File List Interface.

**Special Warning:**

1. For the new edited PCR program, please save first then run it, otherwise the file file can't be run;
2. When setting “Time” as “--:--”, the hotlid will be closed automatically when the block reaches the target temperature.

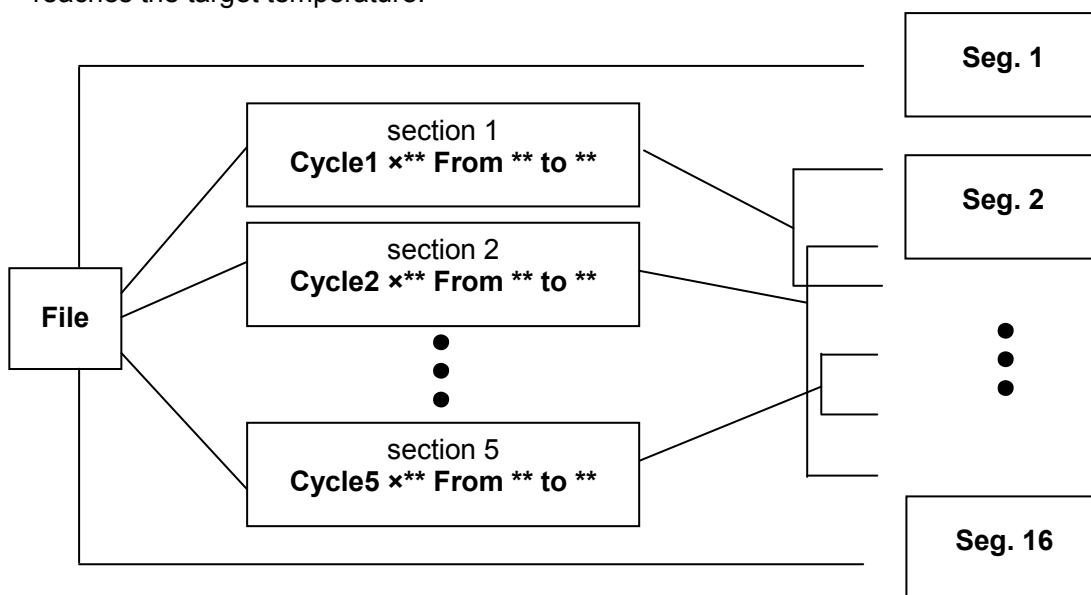

**Relation of sections and segments in a file**

## File Save Interface

In this interface press “**Digit & Letter**” to enter the file name. Press “**Enter**” to move the cursor forwards one position. Select User and File Name through pop-up key. Click left button to delete characters while clicking right button to move the cursor. Press “**Caps**” key to shift the capital or small letter, and there will be a capital or small letter indication on the left top of the screen. (as the example: abc)

- ✧ Press “**Main**” to go back to the main interface.
- ✧ Press “**Save**” to save the file. When the file is normally saved, the system will remind “File have been saved. Please continue another operation”, Press “**Enter**” to cancel the reminding bar. If the file was used, the system will remind you to rename (Rename) or continue to save (Save).
- ✧ If the current Control Mode is Block mode, press “**Run**” to enter file running interface; if the current Control Mode is Tube mode, press “**Run**”, thus a dialog box for indicating to input sample volume will be displayed.

Hotlid=off	2007-07-28 10:05:00
abc	
User:	BIOER
File Name:	PCR1
Password:	*****
Password confirm:	*****
<input type="button" value="Main"/> <input type="button" value="Caps"/> <input type="button" value="Save"/> <input type="button" value="Run"/>	

Please enter sample volume:  
050µl

Press **Character button** to input sample volume according to practical condition. Press “**Back**” to go back file save interface. Press “**Run**” to enter file running interface.

Enter the file save interface, if the user press “**Run**” without pressing “**Save**”, the system will remind “The modifications will be lost after running. Do you still want to run?”

- ✧ Press “**No**” to go back file save interface.
- ✧ Press “**Yes**” to enter file running interface and sample volume input interface. (Note: the modification here cannot be saved after the program is running over.)
- ✧ Press “**Yes**”, if the current Control Mode is Block mode, the program will enter file running interface; if the current Control Mode is Tube mode, the system will pop up a dialog box of sample volume input:

Please enter sample volume:  
050µl

Hotlid=off	2007-07-28 10:05:00
abc	
User:	BIOER
File Name:	PCR1
Password:	*****
Password confirm:	*****
<p>The modifications will be lost after running. Do you still want to run?</p>	
<input type="button" value="Back"/> <input type="button" value="Run"/> <input type="button" value="No"/> <input type="button" value="Yes"/>	

The user can input Sample Volume (Unit: Micro liter) by the same way as that of the main interface. Press “**Back**” to go back to File List Interface, Press “**Run**” to enter into file running interface.

When the file is normally running, “●●●” at “Now Running” will continuously flash. When running is over, the system will remind “File running is over, Press ‘Enter’ back to the main interface.”

- ✧ Press “**Stop**” and it will remind “Do you want to stop running? Please select ‘F1’ or ‘F3’”. According to the reminding information to select “Stop” or “Start”.
- ✧ Press “**Pause**” and it will remind “Pause state now. Press ‘F3’ to continue running.” According to the reminding information you can select “Strat” to continue.
- ✧ Press “**View File**” to view edited PCR programs.
- ✧ Press “**Skip**” to stop current temperature and run the next.

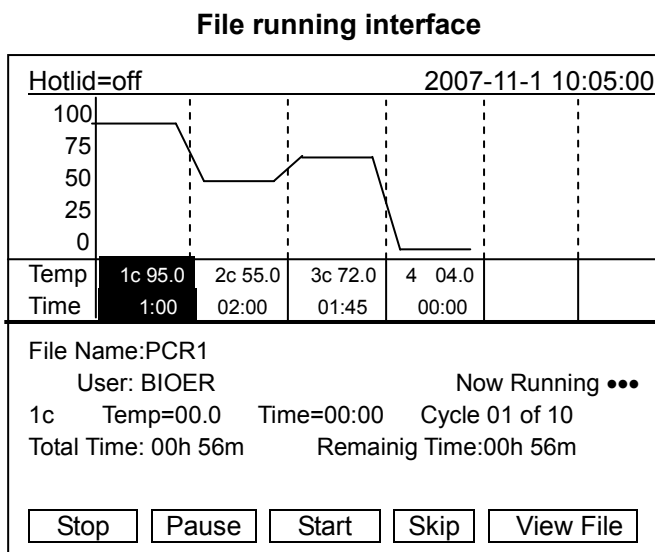

### 3 How to Set System Parameters

In the main interface press “**System**” to enter system parameter setting interface. Press “**Enter**” to move the cursor to next item. The option is followed by the symbol “↕”. Press “**Up/Down**” to roll the option for selecting, and other information can be entered by pressing “**Digit & Letter**”. Press “**Right/Left**” to move cursor’s position.

- ✧ Press “**Back**” to go back to the main menu.
- ✧ Press “**Save**” to save parameters.

**Special Reminding:** When set the parameter, please press the “Save”, otherwise the parameter remains the original one.

**System Parameter Setting Interface**

The screenshot shows the 'System Parameter Setting Interface'. At the top, it displays 'Hotlid=off' and the date/time '2007-07-28 10:06:00'. Below this are several settings, each with a value and a vertical double-headed arrow indicating it can be changed:

- Date(yy-mm-dd): 07-07-28
- Time(hh-mm-ss): 10:06:19
- Default User: BIOER
- Default File: PCR1
- Module Select: 24\*0.2
- Control Mode: Block
- Hotlid Temp: OFF
- Block Temp: 10C
- Key Sound: OFF
- Run End Sound: ON

At the bottom, there are buttons for 'Back' and 'Save'.

**3.1** “Date”and“Time”stand for default time after power-on.

**3.2** “Default File” and “Default User” stand for name and user of default running procedure after power-on.

**3.3** “Module Select” stands for module type, including two optional modes, named “18\*0.5” and “24\*0.2”. Selecting the module type according to the real situation.

**3.4** “Control Mode” stands for default control model after power-on, including two optional modes, named “Block” and “Tube”.

“**Block**” mode subjects to simple temperature control during the course of cooling & heating only. Compared to the block, cooling & heating rate of reagent is a little slower, therefore, the actual change of reagent’s temperature is different from the setting procedure. The actual time for reagent to reach & keep the setting temperature is far shorter than the setting time.

(Please refer to the following figure: relation between block temperature and reagent temperature.)

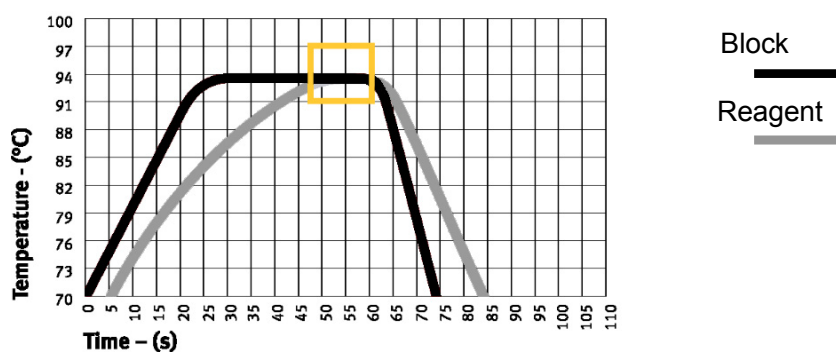

“**Tube mode**” has considered the phenomenon that the cooling & heating rate is a little slower than that of block. There is an overshoot after reaching the setting temperature, which can allow reagent to reach the setting temperature faster. During the same setting time as “Block”, the actual time for reagent to keep the setting temperature is prolonged obviously. (Please refer to the following figure: relation between block temperature and reagent temperature.)

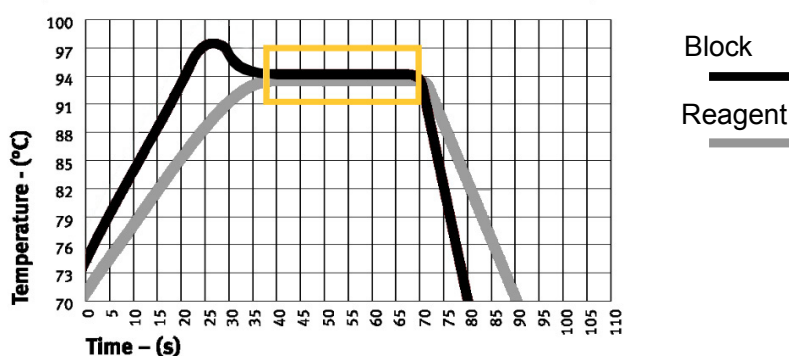

3.5 “Hotlid” stand for the state of hotlid “Open” or “Close”.

3.6 “Key Sound” and “Run End Sound” stand for the sound of pressing key and reminding sound after the procedure runs over respectively.

## CHAPTER 5 UPGRADE OF SOFTWARE

### 1 To Install Upgrading Software

- 1) Choose and click “Setup.exe” in the CD, start up guide procedure, and then press “Next ” to continue installation (refer to the picture below).

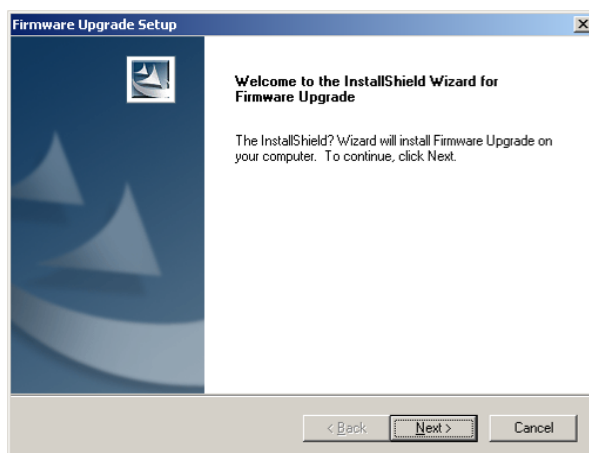

- 2) Please confirm “License Agreement” of the software (refer to the following picture), and press “Yes” to enter into the interface for registration.

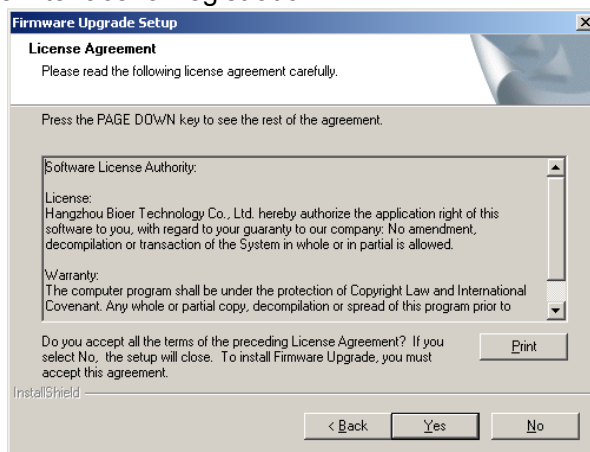

- 3) Please input your information (refer to the following picture), and press “Next” to enter into the installation interface.

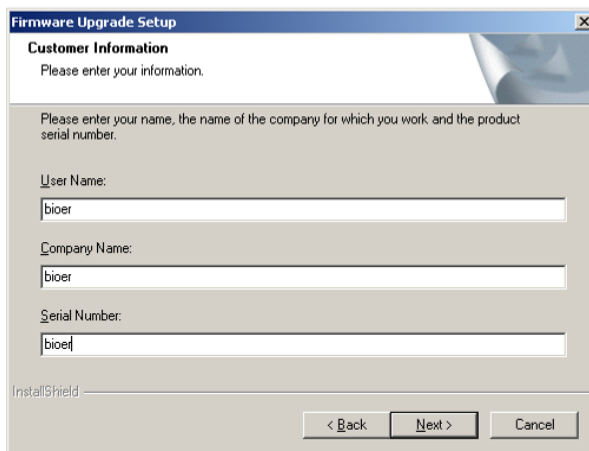

- 4) Please select target installation folder (refer to the following picture), and then press “Next” to enter into the installation interface. The guide procedure will finish installation automatically.

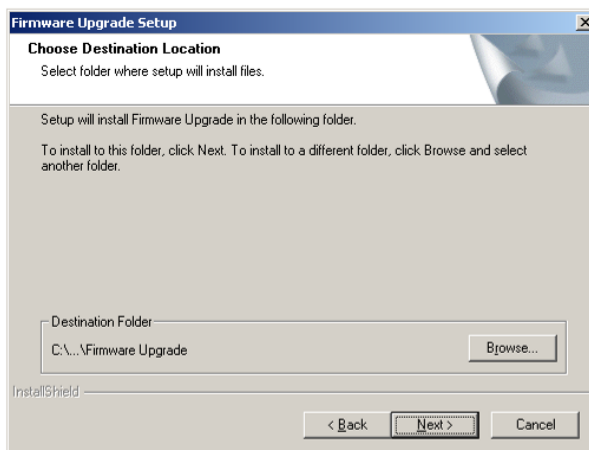

- 5) When the guide procedure shows the installation is over, please confirm by pressing “Finish”.

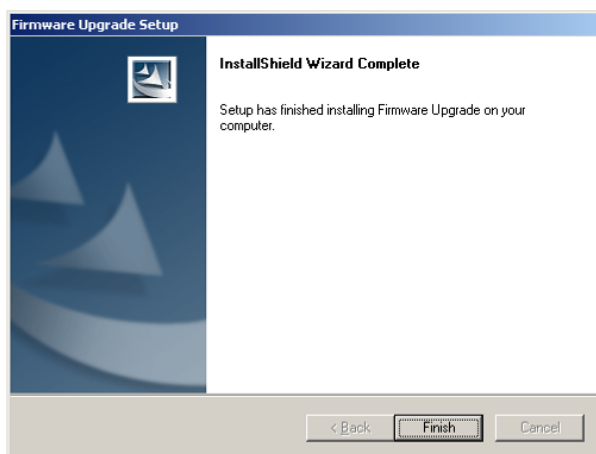

## 2 To Modify, Repair or Remove the Upgraded Software

- 1) If there is an Gene Q Thermal Cycler installation procedure in your computer, click “setup.exe” to start the guide to modify, repair or remove software (refer to the following picture). You can select “Modify”, “Repair” or “Remove”, and then press “Next” to achieve corresponding operation.

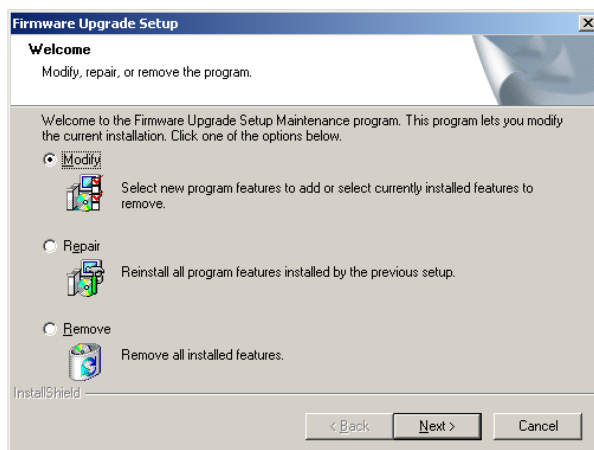

- 2) Click “Modify” and press “Next” to edit installation subassembly, press “Finish ” to finish this step (refer to the following picture).

**Note:** It is necessary to select “Installation file”. If you delete “√” before “installation file”, it will cause incomplete software installation procedure in your operating system.

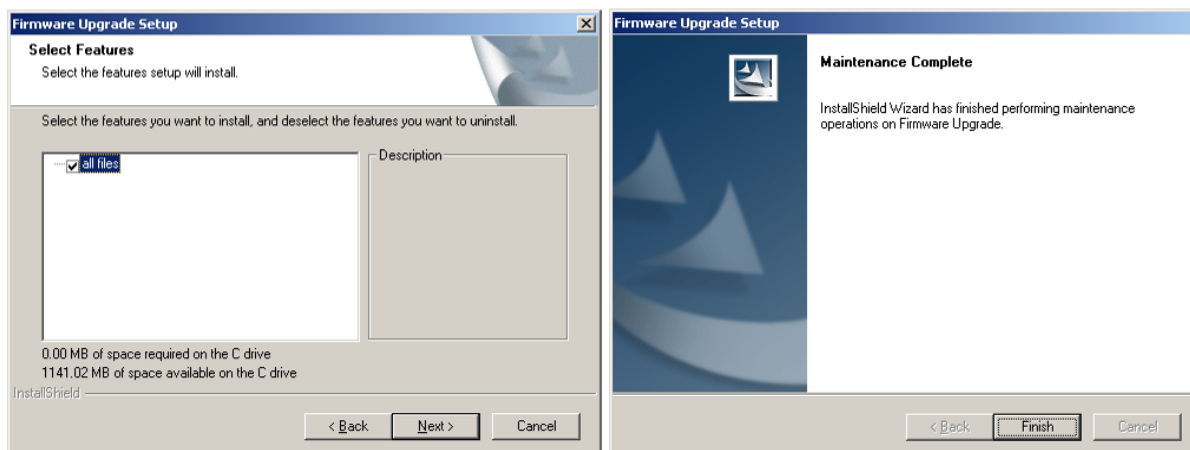

- 3) Click “Repair” and press “Next” to repair installation procedure. Press “Finish” to end this step.

**Note:** The shortage of “all files” can’t be repaired, but you can repair it by choosing “modify” function and then add “all files”.

- 4) Click “Remove” and press “Next” to delete installation procedure. Press “Finish” to end this step.



### 3 Preparation before Upgrading

- 1) Install upgrading software of Gene Q Thermal Cycler into your computer.
- 2) Copy the latest upgrading procedure (\*.bin) into your computer.
- 3) Connect the interface of computer ,“COM1” with the interface of instrument, RS232.
- 4) Power on the instrument, write down the setting value showed in the system parameter setting interface.
- 5) Go back to the main interface and start software upgrading.

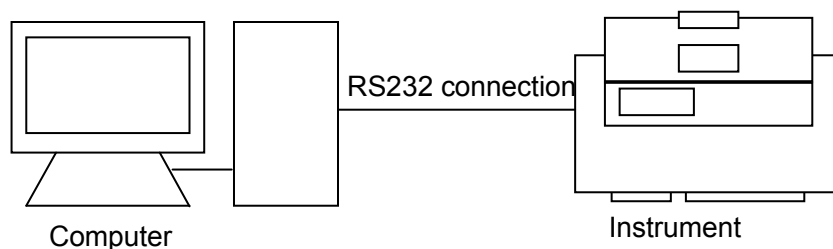

### 4 How to Upgrade the Software

- 1) Press and hold F1 key while powering on the machine to enter software upgrade mode. The screen will display “Prepare to upgrade ●●●”.
- 2) Click “Firmware Upgrade” from the Start menu, or start “Firmware Upgrade.exe” under the folder of upgrading software installation, the screen will show you the upgrading procedure interface (refer to Figure 1). Press “ Expand” to enter into the expansion interface (refer to Figure 2). Press “Test” to test whether the RS232 connection is connected normally. If it is normal, the computer will display “communication is normal”. Press “Compress” to resume the original interface.
- 3) Press “Open”, and select upgrading procedure in the computer (\*.bin).
- 4) Press “Start”, the computer will start to upgrade the software, and the screen of the instrument will display: “Receiving Data ●●●”.
- 5) During software upgrading, the screen will display again: “Configuring Mode ●●●”.
- 6) After software upgrading, the system will remind you: “Upgrade Completed ●●●”.
- 7) Power off the machine, and then restart it to enter into the system parameter setting interface, where you can reset the system parameters.
- 8) Software upgrading is finished.

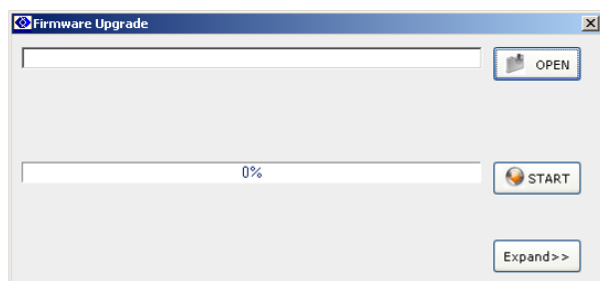

Figure 1

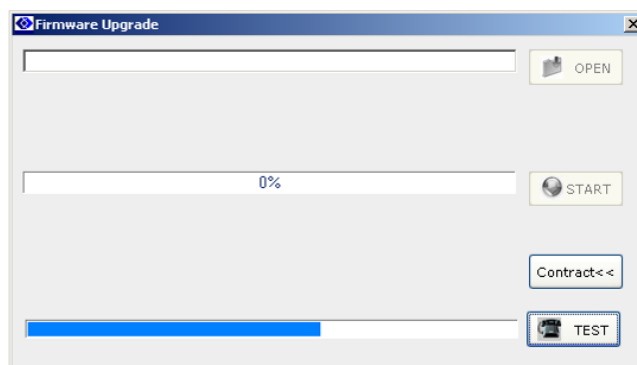

Figure 2

**Note:** Check with the attribute of computer interface, COM1, if it is connected abnormally.

- 1) Open the control panel of computer to click “Device Manager”, and then double-click COM1(as showed in Figure 3);
- 2) Choose “Advanced” in “Communications Port(COM1) Properties”. Revise the “COM Port Number” in “Advanced Settings for COM1”(as showed in Figure 4).

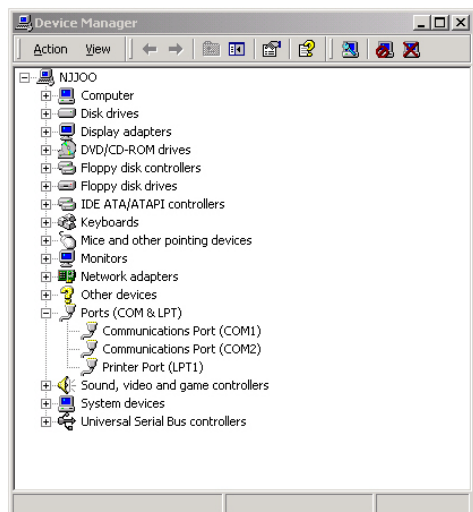

figure 3

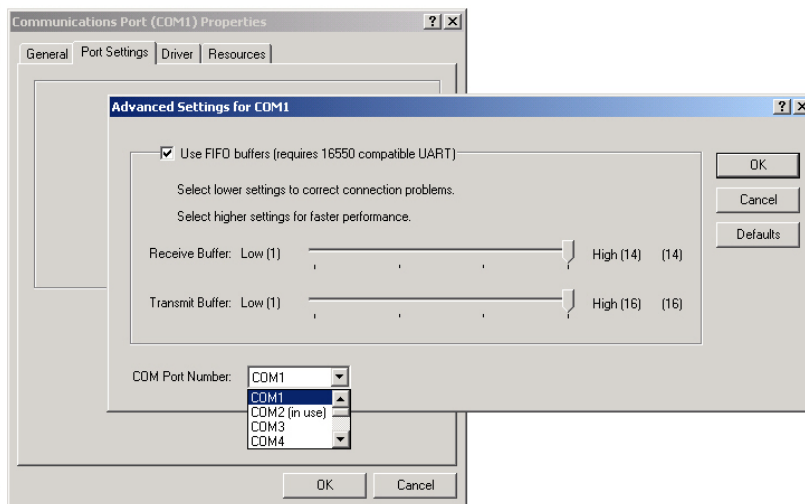

figure 4

---

**Note:** The user can look through [www.bioer.com.cn](http://www.bioer.com.cn) to download the latest procedure.

---

## CHAPTER 6 FAILURE ANALYSIS AND PROCESSING

In this chapter, we briefly represent possible failures, their analysis and processing.

### 1 Failure Analysis and Processing Procedures

No.	Phenomenon	Failure Analysis	Troubleshooting
1	No display and the two beeps missed when power on	Disconnected power supply	Check power supply for correct connection
		Bad fuse	Replace it (250V 2.5A, $\Phi 5 \times 20$ mm or 125V 5A, $\Phi 5 \times 20$ mm )
		Switch failure	Replace it
		Others	Contact distributor or manufacturer
2	Abrupt change in heating speed or bad temperature control accuracy	Ventilation jam	Clear the jam
		Bad connection	Open the device, check the connectors for reliable connection
		Cooling module failure	Contact distributor or manufacturer
3	Significant change in cooling speed, or unavailable temperature below ambient one	Cooling module failure	Contact distributor or manufacturer
		Fan failed or stopped	
4	Heating and cooling terminated	Bad sensor	Contact distributor or manufacturer
		Malfunction of all cooling modules	
5	Lid cannot be heated	Bad contact between connectors	Contact distributor or manufacturer
		Loose connection between connectors	
		Lid heater failure	
		Lid sensor failure	
6	Abnormal characters displayed	Bad contact of chip with its socket	Contact distributor or manufacturer
		Chip malfunctioning	
7	Inactive keys	Film panel destroyed	Contact distributor or manufacturer
8	Reagent in the reaction tubes evaporated	Failure to set hot-lid temperature, but set the hot-lid as "OFF"	Please refer to 《How to set the parameters》 in the Section 1.2, 2.2, 3.2 of Chapter 4, to set the temperature of hot-lid.
		The reaction tubes are placed unevenly	Adjust the hole location of reaction tubes, and place the tubes symmetrically.
		The lid of reaction tubes are closed untightly	Please close the lid of tubes tightly before put them into the instrument.

9	The setup of parameters is invalid	Failure to press "Save" button after the setup of parameters	Please refer to Section 1.2, 2.2 and 3.2 of Chapter4.
10	RS232 interface line testing is unsuccessful	RS232 interface line is loose.	Power off the instrument, upgrade the software, and re-connect the RS232 interface line.
		Wrong setup of COM1 serial port of computer	Check whether the setup of "COM1" serial port of computer is correct or not. (Please refer to Section 4.4 of Chapter4.)

## 2 Blocks Error Message

No.	Error Message	Possible Reasons
1	Error Message when running " <b>Please contact the distributor</b> ", with " <b>AD1213 failure</b> "	The singlechip can not communicate with the AD1213. AD1213 broken or circuit board trouble.
2	Error Message when running " <b>Please contact the distributor.</b> ", with " <b>Heatsink temperature is too high</b> "	Heat sink temp. higher than 70°C, the sensor broken or short circuit or the fan is not working.
3	Error Message when running " <b>Please contact the distributor.</b> ", with " <b>Heatsink sensor is disconnected.</b> "	Heat sink temp. less than 5°C, the sensor broken or short circuit or the fan is not working.
4	Error Message when running " <b>Please contact the distributor.</b> ", with " <b>Temperature sensor No.1 is disconnected.</b> "	Block sensor No.1 is open circuit
5	Error Message when running " <b>Please contact the distributor.</b> ", with " <b>Temperature sensor No.1 is short-circuited.</b> "	Block sensor No.1 is short circuit
6	Error Message when running " <b>Please contact the distributor.</b> ", with " <b>Hotlid sensor is disconnected</b> "	Hot-lid sensor is open circuit
7	Error Message when running " <b>Please contact the distributor.</b> ", with " <b>Hotlid sensor is short- circuited.</b> "	Hot-lid sensor is short circuit

---

**Note:** During warranty terms, please contact distributor or manufacturer if there is a need to open the device to analyze a failure listed in the above table.

---

APPENDIX 1 Connection Diagram (1/2)

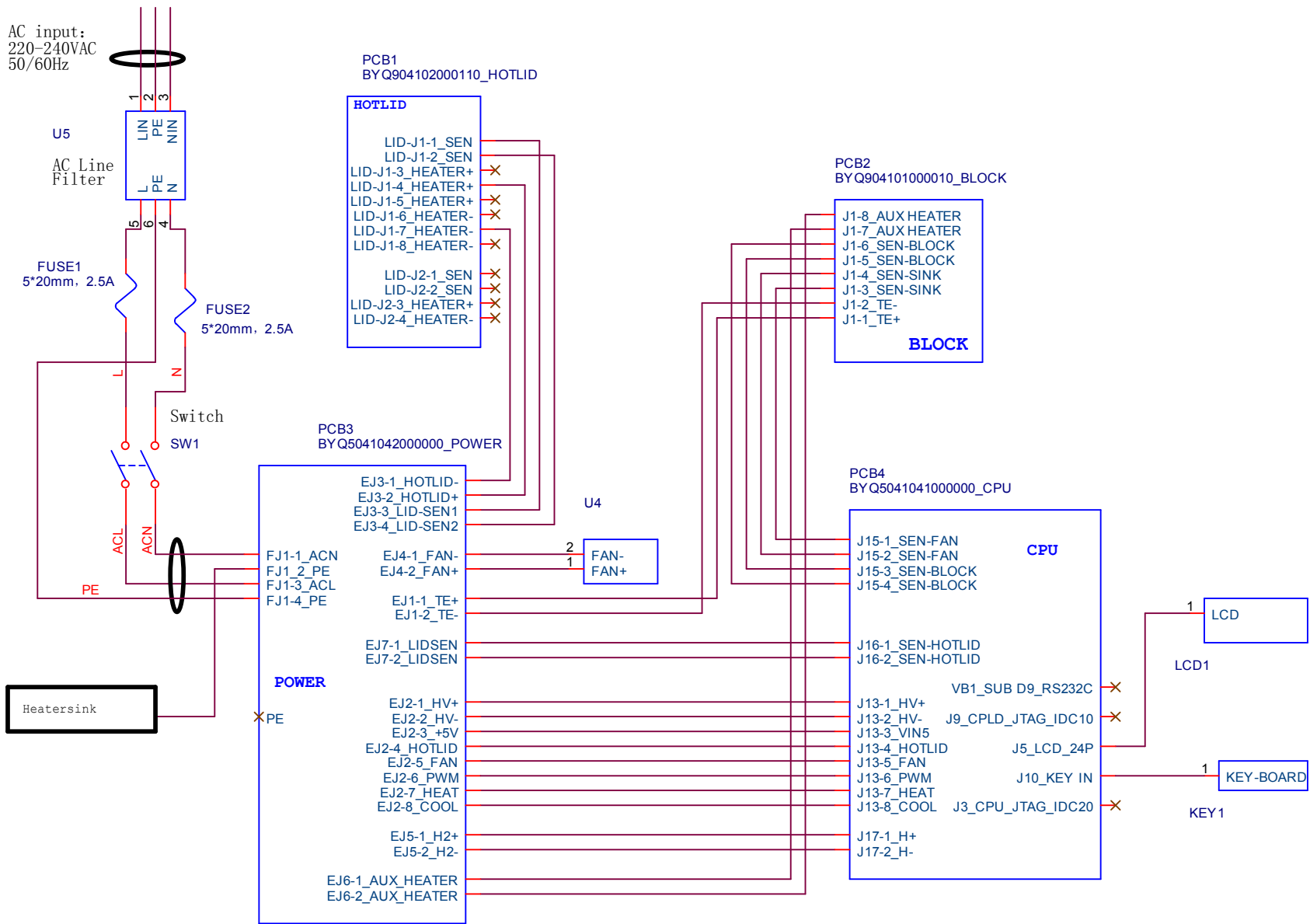

# Connection Diagram (2/2)

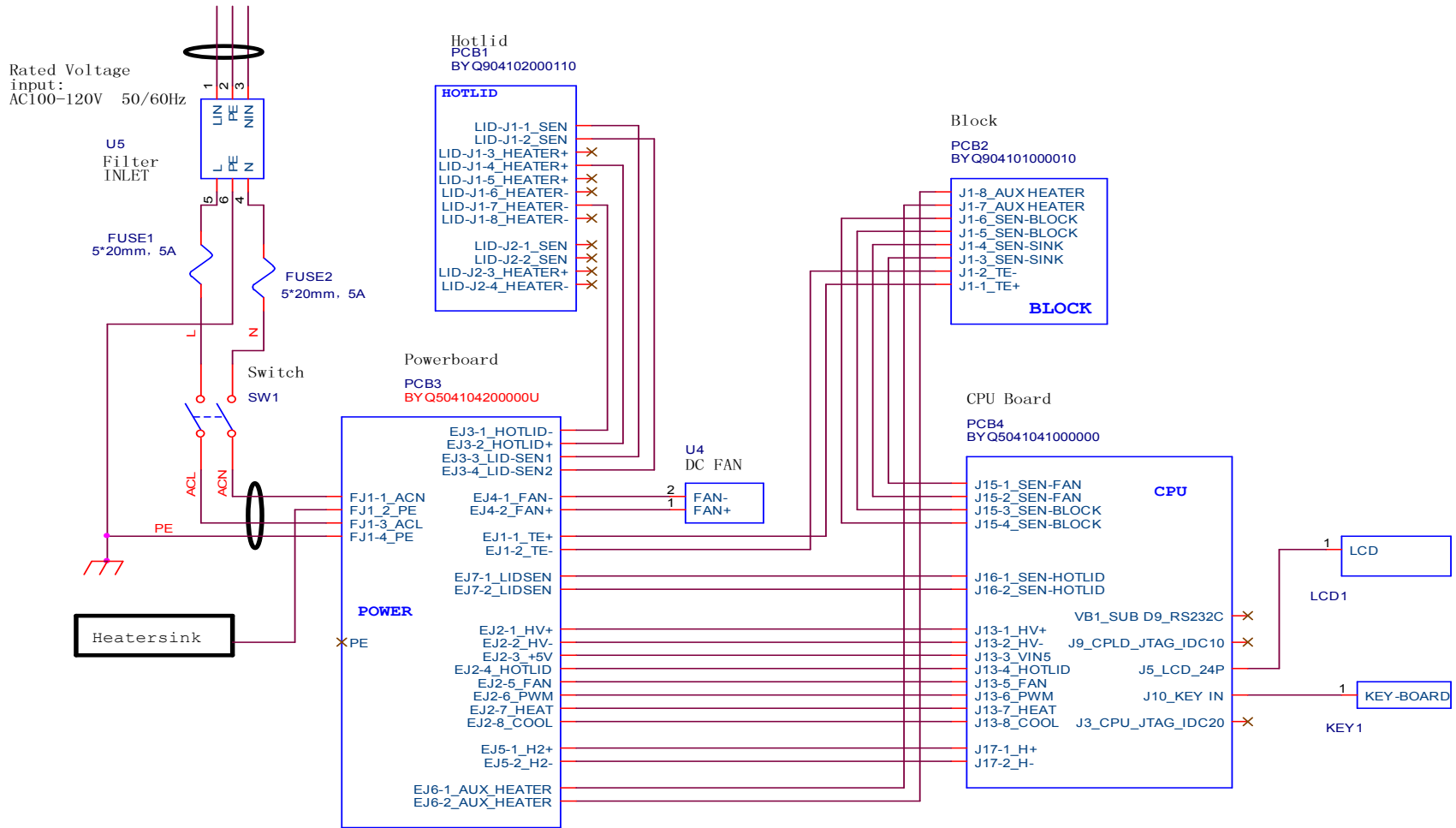

## APPENDIX 2 Parameter Value &amp; Meaning

Item	Parameter	Meaning	Range	Note
1	Temp(C)	Temp. Control point	4.0~99.0	
2	Time	Time of Temp. Control (mm:ss)	--:-- (set the value before ": "through "Function" key.)	The time of Temp. control is long limitlessly, meanwhile, the hotlid closed.
			00: 00~59: 59	
3	Ramp(C/S)	Ramping Rate (°C/Second)	0.1 ~5.0	
			##	Maximum of Ramping Rate
4	+Temp	Temp. Gain of Every Cycler	0.0~9.9	
5	+Time	Time Gain of Every Cycler (mm:ss)	0:00~9:59	
6	Cycle1	Section Numbers	1~5	Cycle1: ×00 From 00 to 00
	×00	Cycler Numbers from beginning to the end	1~99	
	From 00	The start segment of the section	X (and existed segment no.)	
	to 00	The end segment of the section.	≤ X+15	
7	Grad.	Gradient Temp. Difference (°C)	0 ~30	
8	Date	Date(YY-MM-DD)	00(~99)-01(~12)-01(~31)	year-month-date
9	Time	Time(HH:MM:SS)	00:00:00~23:59:59	hour: minute: second
10	Default File	The default file name	Max. length is 11 characters.	
11	Default User	The default user name	Max. length is 11 characters.	
12	Control Mode	Control Mode	Block	Under this mode (once reaching target temperature namely entering into the thermostatical state), the time for reagent's temperature under target temperature is less than setting time (see Fig. 1).
			Tube	Under this mode (once entering into the thermostatical state after reaching target temperature and decreasing about 3°C), reagent's temperature can be close to target temperature very fast (see Fig. 2).
13	Sample Volume	Sample Volume (ul)	10~200	
14	Hotlid Temp	State of Hotlid: OFF	OFF	
		State of Hotlid: Open (°C)	30~99	
15	Block Temp	State of Block Temp during the heating of Hotlid (°C)	0~99	
16	Key Beep	Key Sound (ON or OFF)	OFF/ON	Humming
17	Run End Beep	Run End Sound (ON or OFF)	OFF/ON	Humming continuously

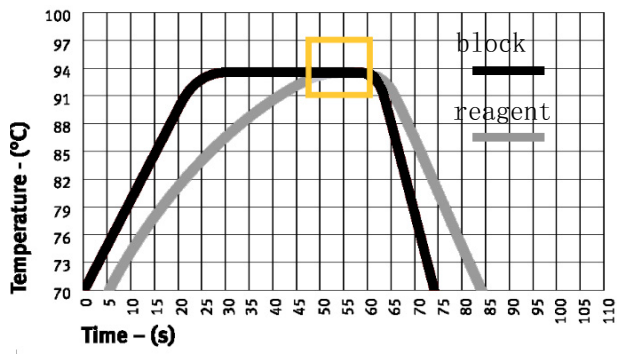

Picture1

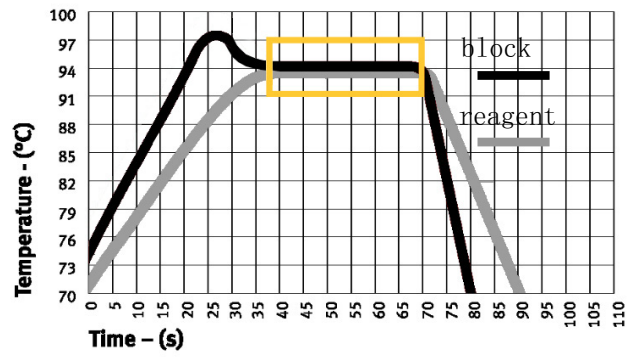

Picture 2



**NOTES**

A large, empty rectangular box with a thin black border, occupying most of the page below the 'NOTES' header. It is intended for the user to write their notes.